

# 安装孔

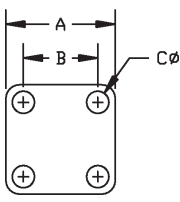

CODE	A	B	C
A01	.500	.340	.102
A02	.687	.500	.109
A03	.687	.500	#3-56 TAP
A04	.687	.500	.125
A05	1.000	.718	.125
A06	.750	.531	.140
A07	.750	.531	.125
A08	1.190	.906	.125
A09	.687	.500	#4-40 TAP
A10	.687	.500	.136
A11	1.250	.975	.147
A12	2.000	1.440	.257
A13	1.000	.718	.141
A14	1.000	.718	.144
A15	.687	.500	.104
A16	.750	.531	.136
A17	.375	.232	.067
A18	.625	.437	.094
A19	1.000	.718	#6-32 TAP
A20	.500	.340	#2-56 TAP
A21	1.250	.975	.142
A22	.375	.232	.093

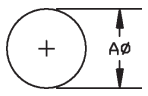

CODE	A
F01	.250
F02	.500
F03	.630
F04	1.200
F05	.380
F06	.450
F07	.200
F08	.362
F09	.220
F10	.317
F11	4.83mm
F12	.390

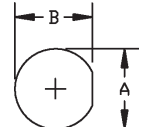

CODE	A	B
B01	.195	.177
B02	.250	.235
B03	.330	.295
B04	.380	.350
B05	.440	.410
B06	.512	.480
B07	.760	.720
B08	.565	.537
B09	.314	.296
B10	.140	.126
B11	.695	.655
B12	.625	.575
B13	.405	.361
B14	.277	.252
B15	.630	.596
B16	.317	.285
B17	.284	.268

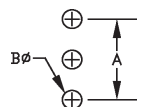

CODE	A	B
J01	.200	.046

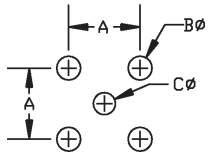

CODE	A	B	C
D01	.200	.067	.062
D02	.200	.067	.046
D03	.100	.031	.031
D04	.200	.052	.052
D05	.260	.067	.043
D06	.200	.052	.047
D07	.200	.055	.043
D08	.200	.067	.035
D09	.200	.055	.028
D10	.200	.055	.035
D11	.320	.091	.031
D12	.400	.062	.062
D13	.320	.091	.091
D14	.340	.091	.043
D15	.164	.067	.091
D16	.500	.126	.440
D17	.380	.083	.043

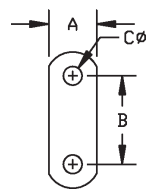

CODE	A	B	C
C01	.223	.481	.102
C02	.260	.481	.102
C03	.192	.328	.067
C04	.640	1.000	.125
C05	.275	.481	.102
C06	.230	.354	.067
C07	.188	.328	.093

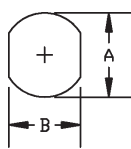

CODE	A	B
G01	.640	.546
G02	.380	.340
G03	.765	.712
G04	.362	.323
G05	.236	.197
G06	.217	.177
G07	.380	.310
G08	1.161	1.000

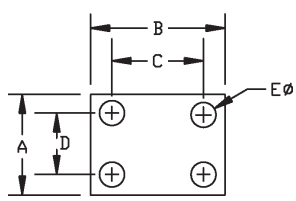

CODE	A	B	C	D	E
E01	.375	.500	.340	.222	.093

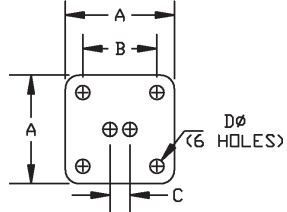

CODE	A	B	C	D
H01	.687	.500	.125	.045