



Double Balanced Mixer Operating from 1 MHz to 2.7 GHz with an IF Range from 1 MHz to 2 GHz and LO Power of +17 dBm, SMA

Mixers Technical Data Sheet

PE86X1021

Features

- Broadband Double Balanced Mixer Design
- High Linearity
- LO & RF Frequency Range: 1 MHz to 2700 MHz
- IF Frequency Range: 1 MHz to 2000 MHz
- LO Drive Level Range: +14 dBm to +20 dBm
- Schottky Ring Quad Diodes with Optimized Balun Structures
- Conversion Loss: 7 dB typ
- Port Isolations up to 38 dB typ
- Very High Input IP3 Level: +27.8 dBm
- RF Input Up to +13 dBm
- SMA Connectors / Designed to Meet MIL-STD-202 Environmental Test Conditions

Applications

- Electronic Warfare
- Point-to-Point Radios
- Point-to-Multipoint Radios
- VSAT
- Radar
- Space Systems
- Test Instrumentation
- Sensors
- Telecom Infrastructure
- Military End-Use

Description

The PE86X1021 is a broadband Double Balanced Mixer that operates across an RF and LO frequency range from 1 MHz to 2700 MHz with an IF frequency range of 1 MHz to 2000 MHz and supports an LO drive level range from +14 to +20 dBm, with +17 dBm nominal. The design utilizes Schottky Ring Quad Diodes with optimized balun structures and exhibits highly linear performance. Exceptional typical performance includes Conversion Loss of 7 dB, RF to LO and LO to IF isolation levels up to 38 dB, and an input IP3 level of +27.8 dBm. The 50 ohm hybrid module does not require any external components or matching circuitry. The rugged compact package assembly supports female SMA connectors, operates over a temperature range of -40°C to +85°C, and is designed to meet MIL-STD-202 environmental test conditions for Humidity, Shock, Vibration, and Altitude for high reliability.

Electrical Specifications

Description	Minimum	Typical	Maximum	Units
RF Frequency Range	0.001		2.7	GHz
LO Frequency Range	0.001		2.7	GHz
IF Frequency Range	0.001		2	GHz
Impedance		50		Ohms
Conversion Loss		7	9.5	dB
LO to RF Isolation	17	38		dB
LO to IF Isolation	16	31		dB
RF Port VSWR		2:1	2.5:1	
LO Port VSWR		1.5:1	2.5:1	
IF Port VSWR		1.5:1	2:1	
Input at 3rd Order Intercept Point	+25	+27.8		dBm
RF Input Power			+13	dBm
LO Input Power		+17		dBm

Click the following link (or enter part number in "SEARCH" on website) to obtain additional part information including price, inventory and certifications: [Double Balanced Mixer Operating from 1 MHz to 2.7 GHz with an IF Range from 1 MHz to 2 GHz and LO Power of +17 dBm, SMA PE86X1021](#)



Double Balanced Mixer Operating from 1 MHz to 2.7 GHz with an IF Range from 1 MHz to 2 GHz and LO Power of +17 dBm, SMA

Mixers Technical Data Sheet

PE86X1021

Absolute Maximum Rating

Parameter	Rating	Units
RF Power	+23	dBm
Operating Temperature	-40 to +85	°C
Storage Temperature	-60 to +100	°C



ESD Sensitive Material,
Transport material in
Approved ESD bags.
Handle only in approved
ESD Workstation.

Mechanical Specifications

Configuration

Design	Double Balanced
Package Type	Connectorized
RF Connector	SMA Female
LO Connector	SMA Female
IF Connector	SMA Female

Environmental Specifications

Temperature

Operating Range	-40 to +85 deg C
Storage Range	-55 to +100 deg C

Humidity
Shock
Vibration
Altitude

MIL-STD-202F, Method 103B, Condition B
MIL-STD-202F, Method 213B, Condition B
MIL-STD-202F, Method 204D, Condition B
MIL-STD-202F, Method 105C, Condition B

Compliance Certifications (see [product page](#) for current document)

Plotted and Other Data

Notes:

Click the following link (or enter part number in "SEARCH" on website) to obtain additional part information including price, inventory and certifications: [Double Balanced Mixer Operating from 1 MHz to 2.7 GHz with an IF Range from 1 MHz to 2 GHz and LO Power of +17 dBm, SMA PE86X1021](#)



Double Balanced Mixer Operating from 1 MHz to 2.7 GHz with an IF Range from 1 MHz to 2 GHz and LO Power of +17 dBm, SMA

Mixers Technical Data Sheet

PE86X1021

Typical Performance Data

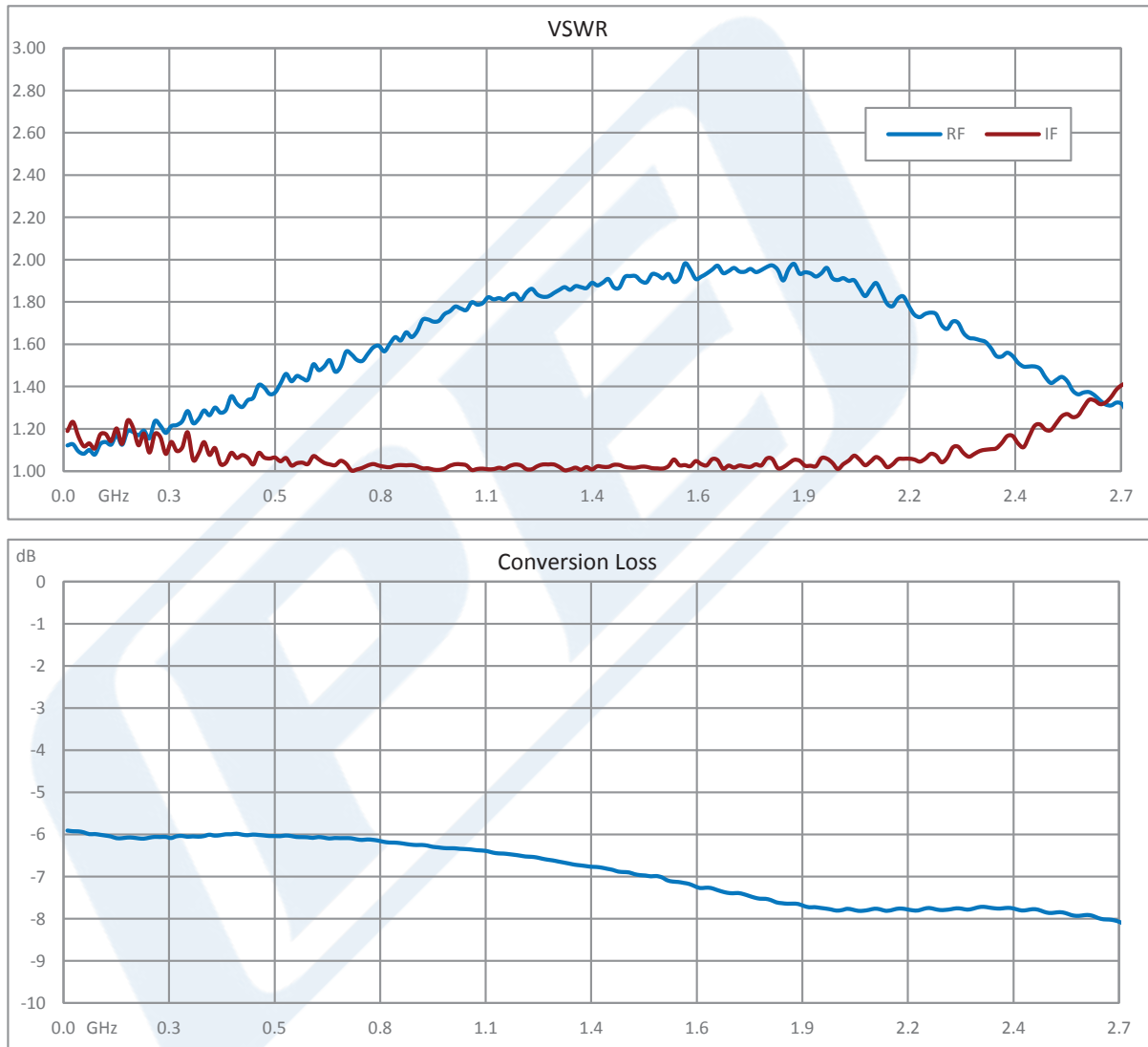

Click the following link (or enter part number in "SEARCH" on website) to obtain additional part information including price, inventory and certifications: [Double Balanced Mixer Operating from 1 MHz to 2.7 GHz with an IF Range from 1 MHz to 2 GHz and LO Power of +17 dBm, SMA PE86X1021](#)



Double Balanced Mixer Operating from 1 MHz to 2.7 GHz with an IF Range from 1 MHz to 2 GHz and LO Power of +17 dBm, SMA

Mixers Technical Data Sheet

PE86X1021

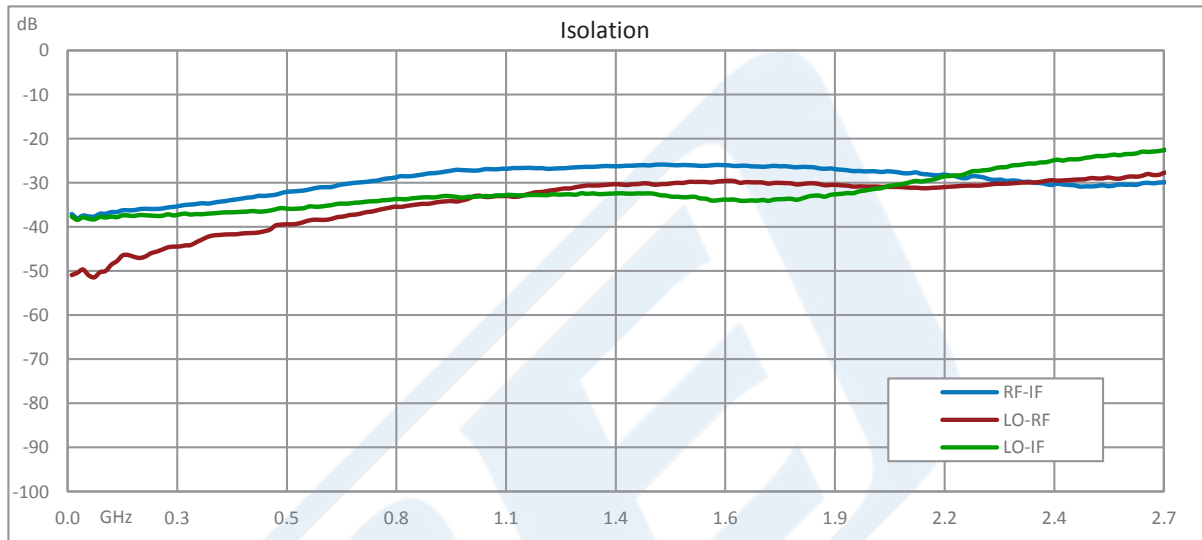

Double Balanced Mixer Operating from 1 MHz to 2.7 GHz with an IF Range from 1 MHz to 2 GHz and LO Power of +17 dBm, SMA from Pasternack Enterprises has same day shipment for domestic and International orders. Our RF, microwave and millimeter wave products maintain a 99.4% availability and are part of the broadest selection in the industry.

Click the following link (or enter part number in "SEARCH" on website) to obtain additional part information including price, inventory and certifications: [Double Balanced Mixer Operating from 1 MHz to 2.7 GHz with an IF Range from 1 MHz to 2 GHz and LO Power of +17 dBm, SMA PE86X1021](https://www.pasternack.com/sma-mixer-1-mhz-2.7-ghz-if-1-mhz-2-ghz-pe86x1021-p.aspx)

URL: <https://www.pasternack.com/sma-mixer-1-mhz-2.7-ghz-if-1-mhz-2-ghz-pe86x1021-p.aspx>

The information contained in this document is accurate to the best of our knowledge and representative of the part described herein. It may be necessary to make modifications to the part and/or the documentation of the part, in order to implement improvements. Pasternack reserves the right to make such changes as required. Unless otherwise stated, all specifications are nominal. Pasternack does not make any representation or warranty regarding the suitability of the part described herein for any particular purpose, and Pasternack does not assume any liability arising out of the use of any part or documentation.

PE86X1021 CAD Drawing

Double Balanced Mixer Operating from 1 MHz to 2.7 GHz with an IF Range from 1 MHz to 2 GHz and LO Power of +17 dBm, SMA

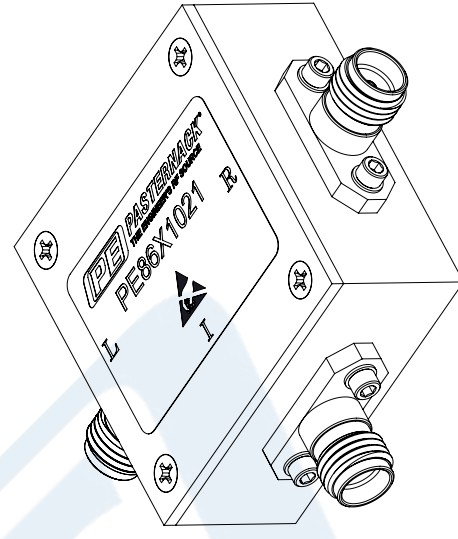
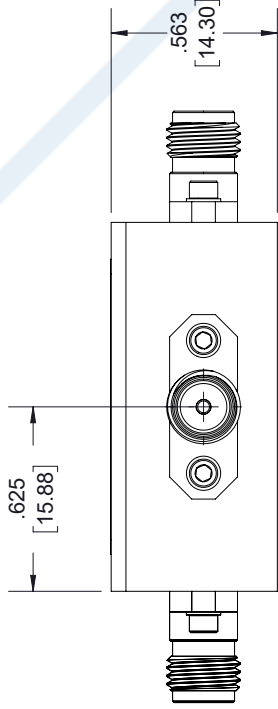
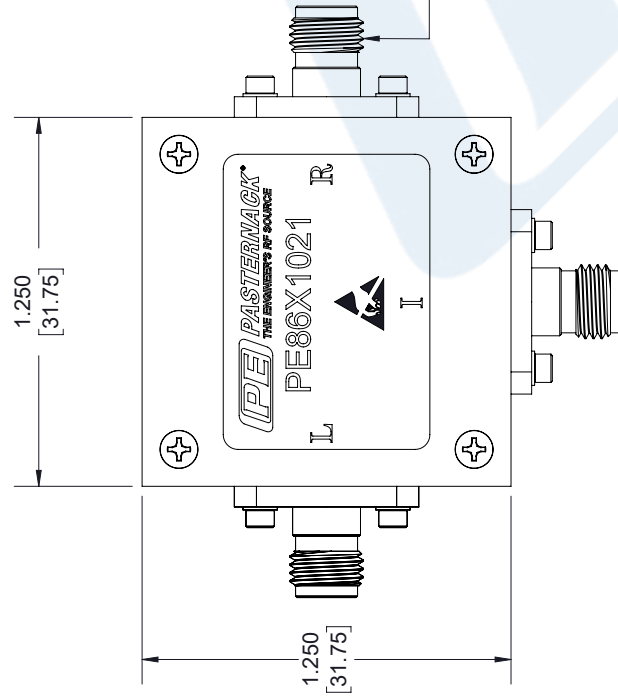
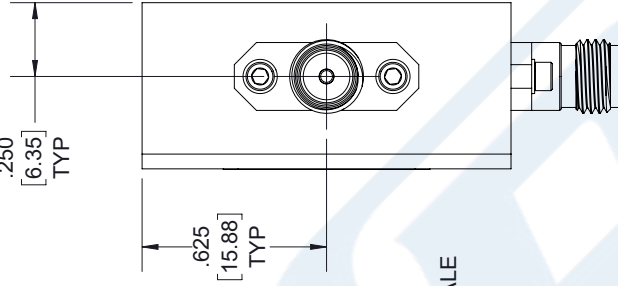
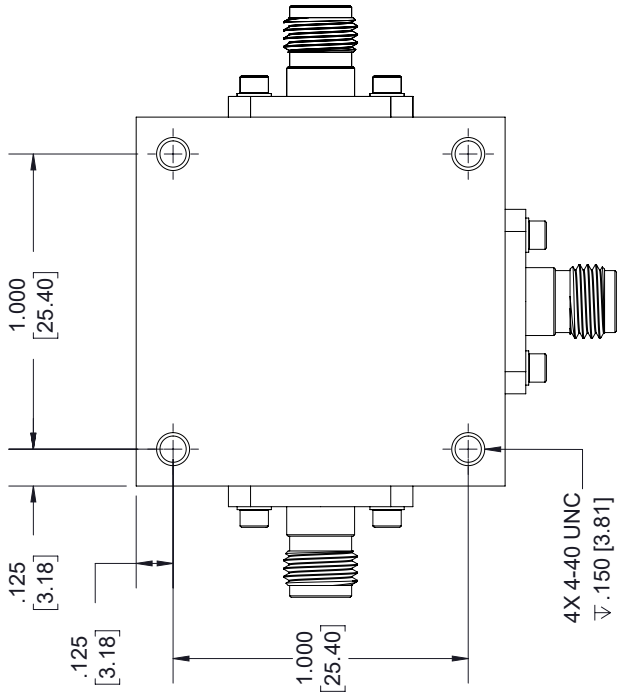

SCHEMATIC

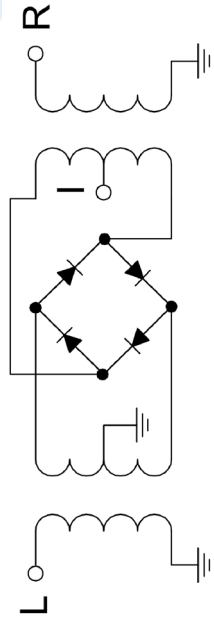

STANDARD TOLERANCES	
.X	±0.2
.XX	±0.01
.XXX	±0.005

*STANDARD TOLERANCES APPLY ONLY TO DIMENSIONS IN INCHES

<p>PEP PASTERNAK THE ENGINEER'S RF SOURCE Pasternack Enterprises, Inc. P.O. Box 16759 Irvine CA 92623 Phone: (949) 261-1920 Fax: (949) 261-7451 Website: www.pasternack.com E-Mail: sales@pasternack.com</p>	DWG TITLE	PE86X1021
	CAGE CODE	53919
NOTES:	<p>1. UNLESS OTHERWISE SPECIFIED ALL DIMENSIONS ARE NOMINAL. 2. ALL SPECIFICATIONS ARE SUBJECT TO CHANGE WITHOUT NOTICE AT ANY TIME. 3. DIMENSIONS ARE IN INCHES [mm].</p>	
CAD FILE	04/26/18	SCALE N/A
SIZE	A	7361