

**MATERIALS**

BODY	BRASS NICKEL PLATED
CONTACT	GOLD PLATED
INSULATOR	PTFE

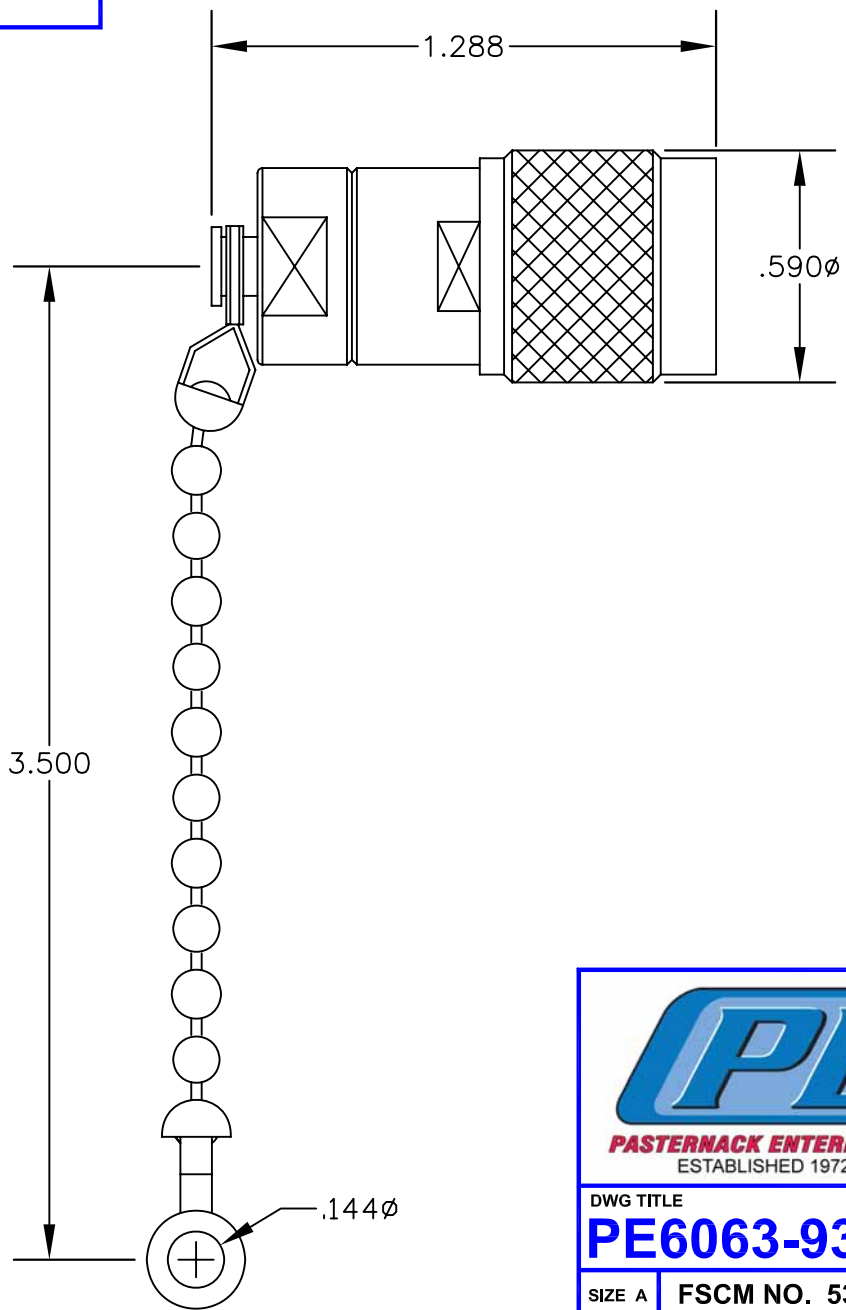

**PASTERNACK ENTERPRISES, INC.**  
 P.O BOX 16759, IRVINE, CA 92623  
 PHONE (949) 261-1920 FAX (949) 261-7451  
 WEB ADDRESS: [www.pasternack.com](http://www.pasternack.com)  
 E-MAIL ADDRESS: [sales@pasternack.com](mailto:sales@pasternack.com)  
**COAXIAL & FIBER OPTICS**

DWG TITLE	<b>PE6063-93</b>			DES.	TNC MALE RESISTOR TERMINATION WITH CHAIN
SIZE A	FSCM NO. 53919	CAD FILE	071502	SCALE	N/A
					127

**NOTES:**  
 1. UNLESS OTHERWISE SPECIFIED ALL DIMENSIONS ARE NOMINAL.  
 2. ALL SPECIFICATIONS ARE SUBJECT TO CHANGE WITHOUT NOTICE AT ANY TIME.