

MATERIALS

BODY	BRASS NICKEL PLATED
CONTACT	GOLD PLATED
INSULATOR	PTFE

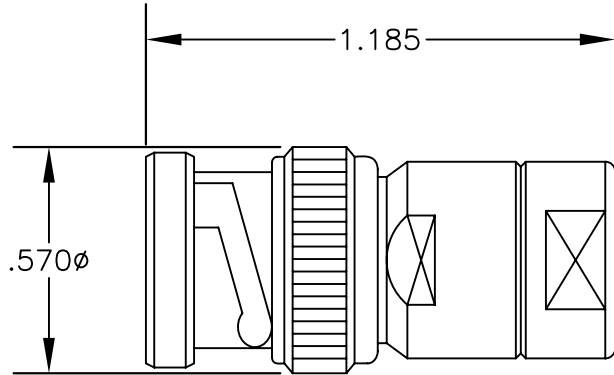

PASTERNACK ENTERPRISES, INC.
 P.O BOX 16759, IRVINE, CA 92623
 PHONE (949) 261-1920 FAX (949) 261-7451
 WEB ADDRESS: www.pasternack.com
 E-MAIL ADDRESS: sales@pasternack.com
COAXIAL & FIBER OPTICS

DWG TITLE		DES. BNC MALE RESISTOR TERMINATION			
PE6000-75					
SIZE A	FSCM NO. 53919	CAD FILE 071802	SCALE N/A		127

NOTES:
 1. UNLESS OTHERWISE SPECIFIED ALL DIMENSIONS ARE NOMINAL.
 2. ALL SPECIFICATIONS ARE SUBJECT TO CHANGE WITHOUT NOTICE AT ANY TIME.