



N Male to N Female Bulkhead Precision Cable
60 Inch Length Using 150 Series Coax, RoHS

TECHNICAL DATA SHEET

PE35952-60

N Male to N Female Bulkhead Precision Cable 60 Inch Length Using 150 Series Coax, RoHS

Configuration

Connector 1	N Male
Connector 2	N Female Bulkhead
Cable Type	150 Series

Electrical Specifications

Frequency Range, GHz	DC to 18
Impedance, Ohms	50
Maximum VSWR	1.4:1
Velocity of Propagation, %	69.5
RF Shielding, dB	90
Maximum Operating Voltage, Vrms	1,900

Electrical Specification Notes: Short lengths up to 24" long may exhibit VSWR measurements up to 9% higher.

Mechanical Specifications

Cable Assembly

Cable Type	150 Series
------------	------------

Temperature

Temperature Operating Range, deg C	-50 to +205
------------------------------------	-------------

Size

Length, in [cm]	60 [152.4]
One Time Minimum Bend Radius, in [mm]	1 [25.4]

Cable

Center Conductor Type	Solid
Cable Inner Conductor	Copper Clad Steel, Silver
No of Shields	1
Dielectric Type	PTFE
Jacket Material	FEP
Jacket Diameter, in [mm]	0.15 [3.81]

Connector 1

Type	N Male
Configuration	Straight
Inner Conductor Material and Plating	Gold
Outer Conductor Material and Plating	Passivated Stainless Steel
Coupling Nut Material and Plating	Brass, Nickel
Body Material and Plating	Passivated Stainless Steel

Click the following link (or enter part number in "SEARCH" on website) to obtain additional part information including price, inventory and certifications: [N Male to N Female Bulkhead Precision Cable 60 Inch Length Using 150 Series Coax, RoHS PE35952-60](#)

The information contained in this document is accurate to the best of our knowledge and representative of the part described herein. It may be necessary to make modifications to the part and/or the documentation of the part, in order to implement improvements. Pasternack reserves the right to make such changes as required. Unless otherwise stated, all specifications are nominal.



N Male to N Female Bulkhead Precision Cable
60 Inch Length Using 150 Series Coax, RoHS

TECHNICAL DATA SHEET

PE35952-60

Dielectric Type

PTFE

Connector 2

Type

N Female Bulkhead

Configuration

Straight

Mount Method

Bulkhead

Inner Conductor Material and Plating

Gold

Body Material and Plating

Brass, Nickel

Dielectric Type

PTFE

Compliance Certifications (visit www.Pasternack.com for current document)

RoHS Compliant

Yes

Plotted and Other Data

Notes:

Values at 25 °C, sea level

N Male to N Female Bulkhead Precision Cable 60 Inch Length Using 150 Series Coax, RoHS from Pasternack Enterprises has same day shipment for domestic and International orders. Our RF, microwave and fiber optic products maintain a 99% availability and are part of the broadest selection in the industry.

Click the following link (or enter part number in "SEARCH" on website) to obtain additional part information including price, inventory and certifications: [N Male to N Female Bulkhead Precision Cable 60 Inch Length Using 150 Series Coax, RoHS PE35952-60](http://www.pasternack.com/n-male-n-female-150-series-cable-assembly-pe35952-60-p.aspx)

URL: <http://www.pasternack.com/n-male-n-female-150-series-cable-assembly-pe35952-60-p.aspx>

The information contained in this document is accurate to the best of our knowledge and representative of the part described herein. It may be necessary to make modifications to the part and/or the documentation of the part, in order to implement improvements. Pasternack reserves the right to make such changes as required. Unless otherwise stated, all specifications are nominal.

PE35952-60 CAD Drawing

N Male to N Female Bulkhead Precision Cable 60 Inch Length Using 150 Series Coax, RoHS

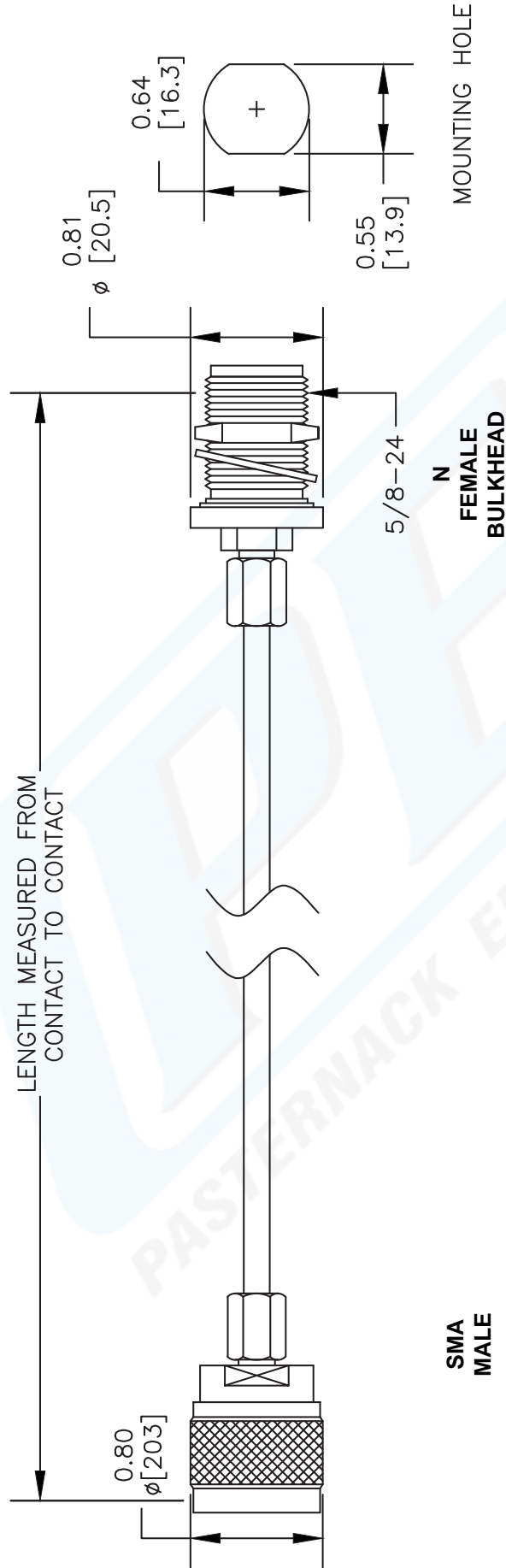

How To Order		Part # Ext.	Length In Inches	Part # Ext.	Length In Centimeters
Part Number Configuration PE3 [zzz] [yy] - [xx] [uu] 00 - 99999 LF = RoHS Compliant < Blank > = Standard Note: LF applies only to RF cables	Examples	-12	12"	-25CM	25Cm
	PE3000LF-100	-24	24"	-50CM	50Cm
	PE3000-100	-36	36"	-75CM	75Cm
	PE3000LF-100CM	-48	48"	-100CM	100Cm
	PE3000-100CM	-60	60"	-125CM	125Cm
		-xx	Custom Length	-xxCM	Custom Length

NOTES:
 1. UNLESS OTHERWISE SPECIFIED ALL DIMENSIONS ARE NOMINAL.
 2. ALL SPECIFICATIONS ARE SUBJECT TO CHANGE WITHOUT NOTICE AT ANY TIME.
 3. DIMENSIONS ARE IN INCHES [mm].
 4. LENGTH TOLERANCE IS ± 1.5% OR 3/8", WHICHEVER IS GREATER.

DWG TITLE
PE35952

PE PASTERNAK®
 Pasternack Enterprises, Inc.
 P.O. Box 16759 | Irvine | CA | 92623
 Phone: (949) 261-1920 | Fax: (949) 261-7451
 Website: www.pasternack.com | E-Mail: sales@pasternack.com

FSCM NO. 53919

CAD FILE 030508

SCALE N/A

SIZE A

2233