



WR-19 Instrumentation Grade Straight Waveguide
 Section 3 Inch Length with UG383/U-Mod Flange
 Operating from 40 GHz to 60 GHz

TECHNICAL DATA SHEET

PE-W19S001-3

Pasternack's instrumentation grade waveguide sections are constructed of a high quality oxygen free hard copper with high precision mechanical tolerances as tight as ± 0.001 " that ensures repeatable and consistent RF performance. Our commercial and instrumentation grade waveguide sections range in size from WR-12 to WR-137 and include grooved and non-grooved flanged designs. Standard lengths of Pasternack waveguide sections are offered from 3" to 12" in 3" increments and each waveguide section is labeled for easy identification. Custom lengths are available upon request. Our commercial grade waveguide sections are painted blue and our instrumentation grade versions are hard gold plated over a copper flash.

- WR-12 to WR-137 Waveguide Sections
- Grooved and Non-Grooved Flange Designs
- Available for frequency ranges between 5.8 GHz to 90 GHz
- Comprehensive waveguide offering also includes E-Bends, H-Bends, Waveguide to Coax Adapters, Filters, Terminations, and more.
- High Precision Tolerance as Tight as ± 0.001 "

Electrical Specifications

Description	Minimum	Typical	Maximum	Units
Frequency Range	40		60	GHz
VSWR			1.06:1	
Insertion Loss			0.15 [0.49]	dB/ft [dB/m]

Mechanical Specifications

Waveguide Size: WR-19
 Waveguide Design: Instrumentation Grade
 Section Length: 3 in [76.2 mm]

Description	Flange 1	Waveguide	Flange 2
Interface	UG383/U-Mod	WR-19	UG383/U-Mod
Material	Oxygen Free Hard Copper	Oxygen Free Hard Copper	Oxygen Free Hard Copper
Plating	Hard Gold over Copper Flash	Hard Gold over Copper Flash	Hard Gold over Copper Flash
Color	Gold	Gold	Gold

Compliance Certifications (visit www.Pasternack.com for current document)

RoHS Compliant

Notes:

- Values at +25 °C, sea level

Click the following link (or enter part number in "SEARCH" on website) to obtain additional part information including price, inventory and certifications: WR-19 Instrumentation Grade Straight Waveguide Section 3 Inch Length with UG383/U-Mod Flange Operating from 40 GHz to 60 GHz PE-W19S001-3



WR-19 Instrumentation Grade Straight Waveguide
Section 3 Inch Length with UG383/U-Mod Flange
Operating from 40 GHz to 60 GHz

TECHNICAL DATA SHEET PE-W19S001-3

Power Data

Outline Drawing

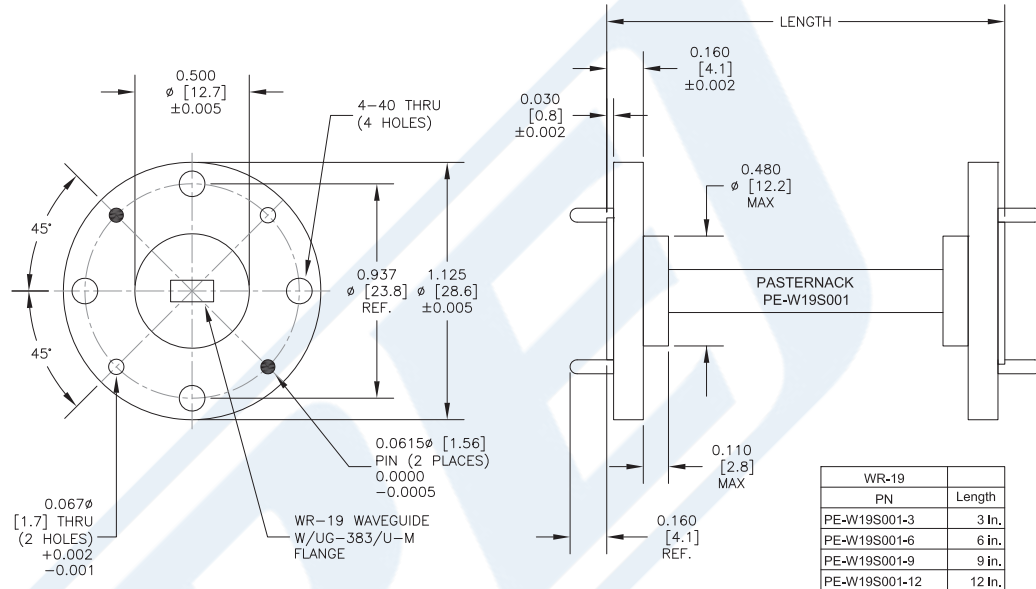

WR-19 Instrumentation Grade Straight Waveguide Section 3 Inch Length with UG383/U-Mod Flange Operating from 40 GHz to 60 GHz from Pasternack Enterprises has same day shipment for domestic and International orders. Our RF, microwave and millimeter wave products maintain a 99% availability and are part of the broadest selection in the industry.

Click the following link (or enter part number in "SEARCH" on website) to obtain additional part information including price, inventory and certifications: [WR-19 Instrumentation Grade Straight Waveguide Section 3 Inch Length with UG383/U-Mod Flange Operating from 40 GHz to 60 GHz PE-W19S001-3](http://www.pasternack.com/wr-19-straight-waveguide-section-ug383-mod-40-60-ghz-pe-w19s001-3-p.aspx)

URL: <http://www.pasternack.com/wr-19-straight-waveguide-section-ug383-mod-40-60-ghz-pe-w19s001-3-p.aspx>

The information contained in this document is accurate to the best of our knowledge and representative of the part described herein. It may be necessary to make modifications to the part and/or the documentation of the part, in order to implement improvements. Pasternack reserves the right to make such changes as required. Unless otherwise stated, all specifications are nominal. Pasternack does not make any representation or warranty regarding the suitability of the part described herein for any particular purpose, and Pasternack does not assume any liability arising out of the use of any part or documentation.